

# Exploded view and spare part list

Model: YMSJXC (H) 024BAAN--X

Voltage: 208/230-60-1

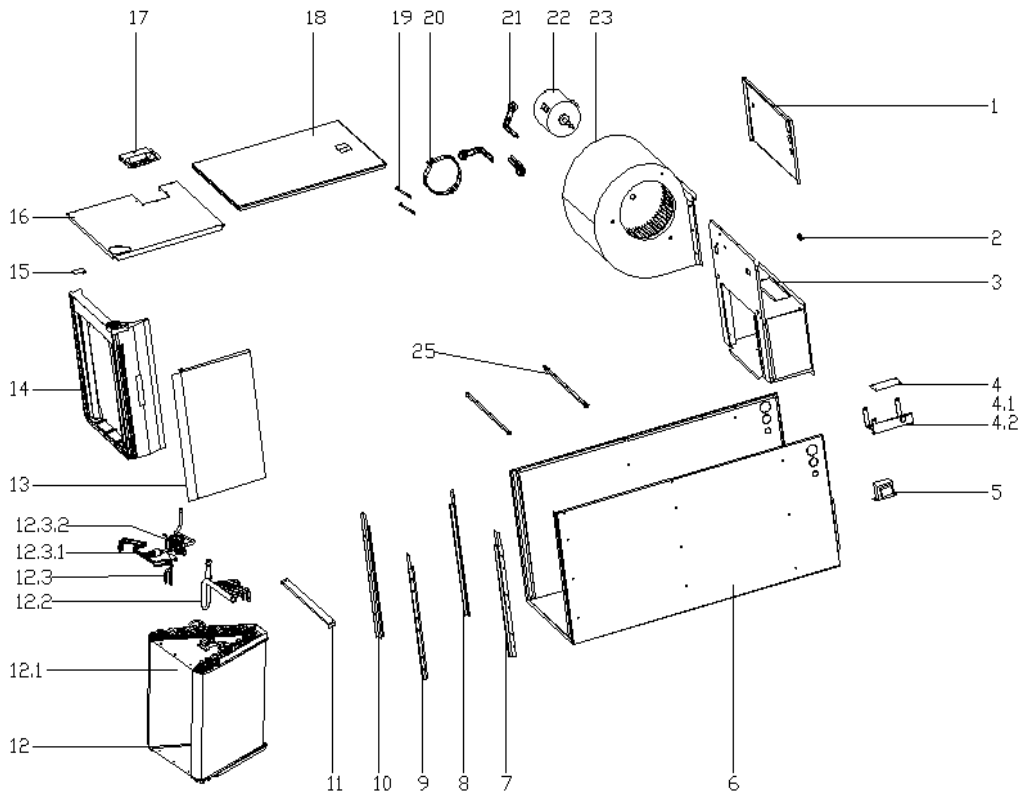

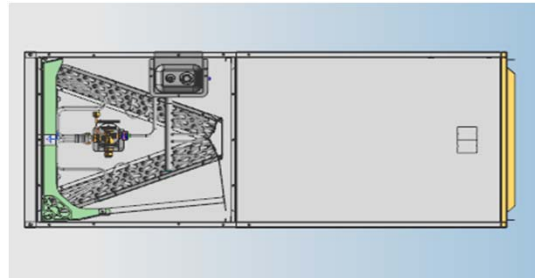
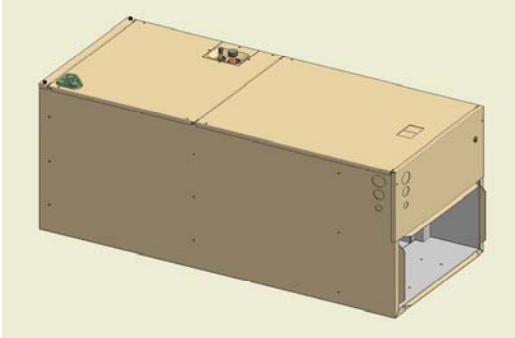
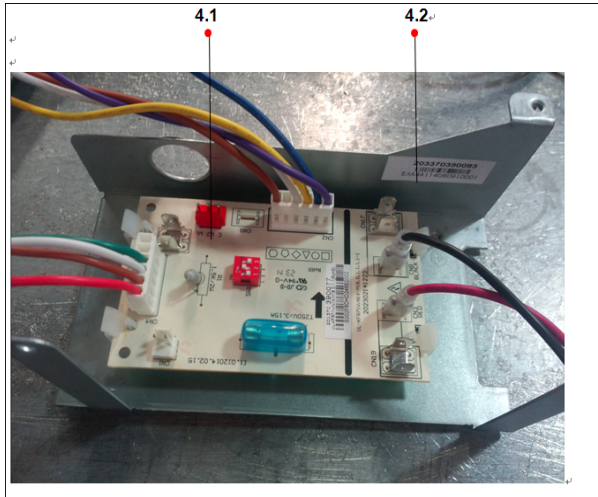

No.	Part Name	Quantity	BOM code	York Model	Remark
1	Side board ass'y	1	201M270590079	YMS JXC (H) 024BAAN--X	
2	Grounding terminal	1	202M301440007	YMS JXC (H) 024BAAN--X	
3	Duct components	1	201M270490108	YMS JXC (H) 024BAAN--X	
4	E-part box ass'y	1	203M370390083	YMS JXC (H) 024BAAN--X	
4.1	Main control board ass'y	1	201M370390077	YMS JXC (H) 024BAAN--X	recommended
4.2	Electric installation board	1	201M270590096	YMS JXC (H) 024BAAN--X	
5	Transformer	1	202M300930295	YMS JXC (H) 024BAAN--X	recommended
6	Base ass'y	1	201M270590088	YMS JXC (H) 024BAAN--X	
7	Drainage pan supporting board	1	201M270590081	YMS JXC (H) 024BAAN--X	
8	Drainage pan supporter ass'y IV	1	201M270590153	YMS JXC (H) 024BAAN--X	
9	Drainage pan supporting board	1	201M270590082	YMS JXC (H) 024BAAN--X	
10	Drainage pan supporter ass'y III	1	201M270590151	YMS JXC (H) 024BAAN--X	
11	Cover board	1	201M270590080	YMS JXC (H) 024BAAN--X	
12	Evaporator ass'y	1	201M570390087	YMS JXC (H) 024BAAN--X	
12.1	Evaporator	2	201M570590044	YMS JXC (H) 024BAAN--X	
12.2	Evaporator tube assembly output	1	201M670390280	YMS JXC (H) 024BAAN--X	
12.3	Enter the evaporator tube assembly	1	201M670390281	YMS JXC (H) 024BAAN--X	
12.3.1	Distributor	1	201M600500030	YMS JXC (H) 024BAAN--X	
12.3.2	Expansion valve	1	201M601300510	YMS JXC (H) 024BAAN--X	
13	Drainage pan	1	201M270590091	YMS JXC (H) 024BAAN--X	
14	Drain pan ass'y	1	201M170590012	YMS JXC (H) 024BAAN--X	
15	Drainage pan clap	1	201M270390194	YMS JXC (H) 024BAAN--X	
16	Baffle ass'y	1	201M2705A0065	YMS JXC (H) 024BAAN--X	
17	Cover plate ass'y	1	201M270390192	YMS JXC (H) 024BAAN--X	
18	Side board ass'y	1	201M270590087	YMS JXC (H) 024BAAN--X	
19	2 water tray brace	2	201M270390363	YMS JXC (H) 024BAAN--X	
20	Motor bracket II	1	201M270390273	YMS JXC (H) 024BAAN--X	
21	I motor bracket assembly	3	201M270290059	YMS JXC (H) 024BAAN--X	
22	DC fan motor	1	202M400300548	YMS JXC (H) 024BAAN--X	recommended
23	Fan ass'y	1	201M200300834	YMS JXC (H) 024BAAN--X	
24	Supporting bar	1	201M270590083	YMS JXC (H) 024BAAN--X	

# Exploded view and spare part list

Model: YMSJXC (H) 036BAAN--X

Voltage: 208/230-60-1

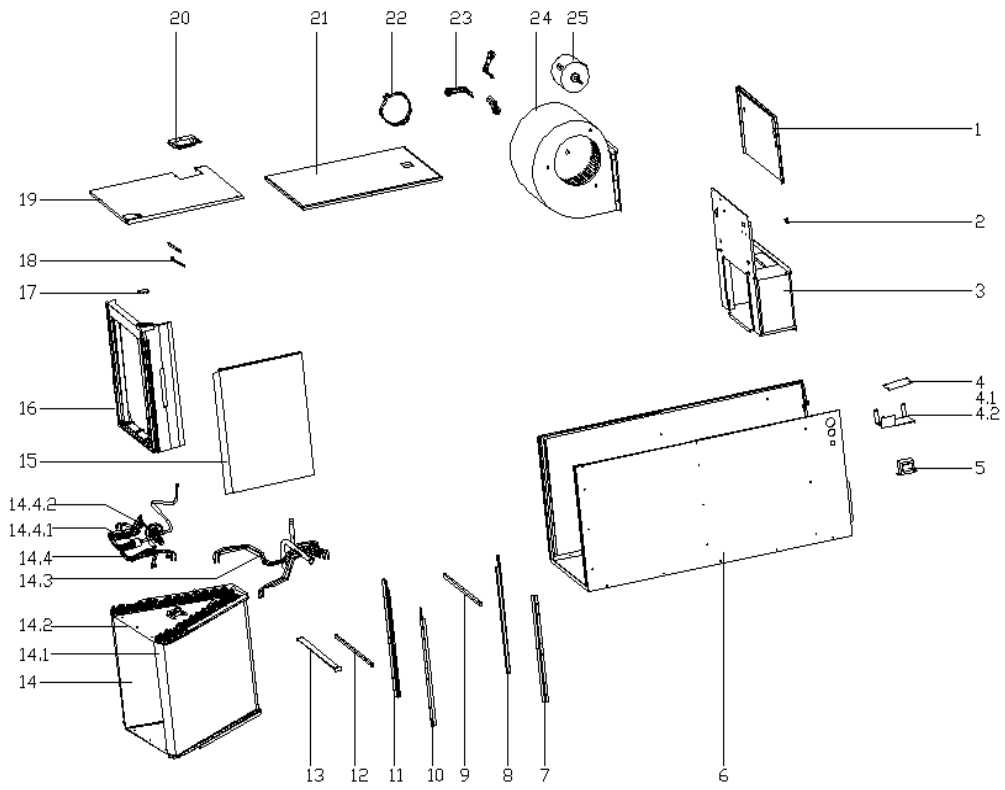
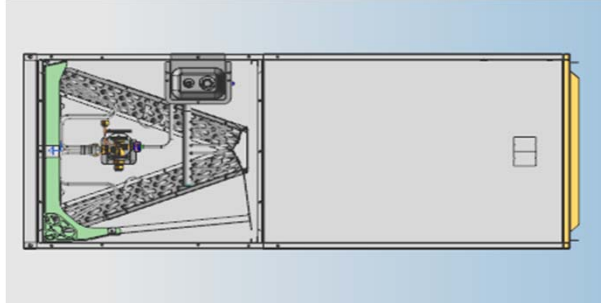
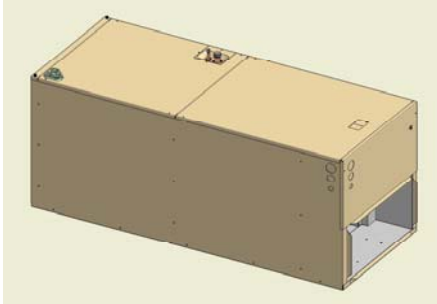

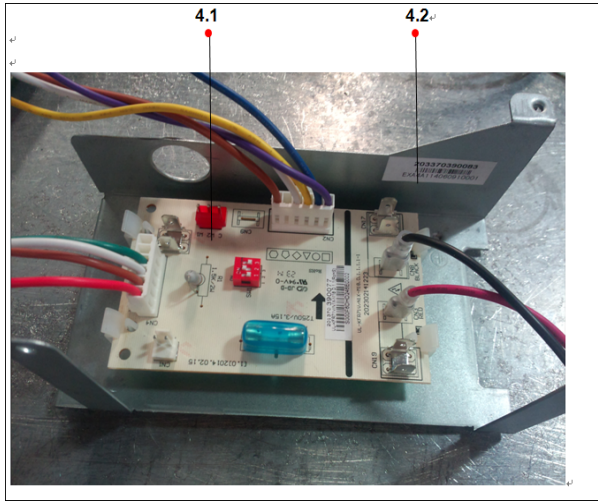

No.	Part Name	Quantity	BOM code	York Model	Remark
1	Side board ass'y	1	201M270890064	YMSJXC (H) 036BAAN--X	
2	Grounding terminal	1	202M301440007	YMSJXC (H) 036BAAN--X	
3	Air duct ass'y	1	201M270890101	YMSJXC (H) 036BAAN--X	
4	E-part box ass'y	1	203M370390083	YMSJXC (H) 036BAAN--X	
4.1	Main control board ass'y	1	201M370390077	YMSJXC (H) 036BAAN--X	recommended
4.2	Electric installation board	1	201M270590096	YMSJXC (H) 036BAAN--X	
5	Transformer	1	202M300930295	YMSJXC (H) 036BAAN--X	recommended
6	Base ass'y	1	201M270890076	YMSJXC (H) 036BAAN--X	
7	Drainage pan supporting board	1	201M270890067	YMSJXC (H) 036BAAN--X	
8	Drainage pan supporter ass'y	1	201M270890135	YMSJXC (H) 036BAAN--X	
9	Supporter ass'y	1	201M270890107	YMSJXC (H) 036BAAN--X	
10	Drainage pan supporting board	1	201M270890066	YMSJXC (H) 036BAAN--X	
11	Water tray supporting welding pieces III	1	201M270890133	YMSJXC (H) 036BAAN--X	
12	Supporting bar	1	201M270890069	YMSJXC (H) 036BAAN--X	
13	Cover board	1	201M270890065	YMSJXC (H) 036BAAN--X	
14	Evaporator parts	1	201M570590127	YMSJXC (H) 036BAAN--X	
14.1	Evaporator	1	201M570590122	YMSJXC (H) 036BAAN--X	
14.2	Evaporator	1	201M570590123	YMSJXC (H) 036BAAN--X	
14.3	Evaporator output pipe ass'y	1	201M670590299	YMSJXC (H) 036BAAN--X	
14.4	Evaporator input pipe ass'y	1	201M670590300	YMSJXC (H) 036BAAN--X	
14.4.1	Distributor	1	201M600500118	YMSJXC (H) 036BAAN--X	
14.4.2	Expansion valve	1	201M601300510	YMSJXC (H) 036BAAN--X	
15	Drainage pan	1	201M270890068	YMSJXC (H) 036BAAN--X	
16	Drain pan ass'y	1	201M170890005	YMSJXC (H) 036BAAN--X	
17	Drainage pan clap	1	201M270390194	YMSJXC (H) 036BAAN--X	
18	2 water tray brace	2	201M270390363	YMSJXC (H) 036BAAN--X	
19	Baffle ass'y	1	201M2708A0027	YMSJXC (H) 036BAAN--X	
20	Cover plate ass'y	1	201M270390192	YMSJXC (H) 036BAAN--X	
21	Upside board ass'y	1	201M270890075	YMSJXC (H) 036BAAN--X	
22	Motor bracket II	1	201M270390273	YMSJXC (H) 036BAAN--X	
23	I motor bracket assembly	3	201M270290059	YMSJXC (H) 036BAAN--X	
24	Centrifugal fan	1	201M200300894	YMSJXC (H) 036BAAN--X	recommended
25	DC fan motor	1	202M400300549	YMSJXC (H) 036BAAN--X	recommended

# Exploded view and spare part list

Model: YMSJXC (H) 048BAAN--X

Voltage: 208/230-60-1

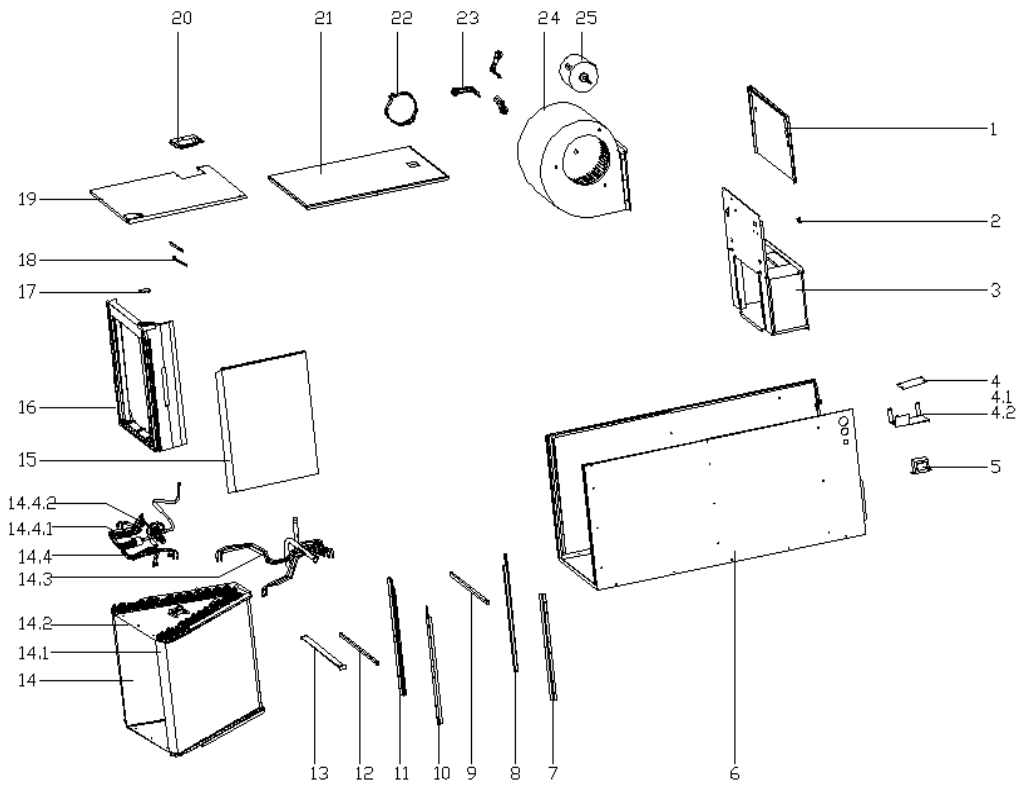
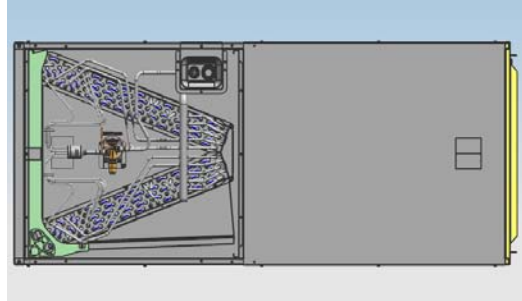
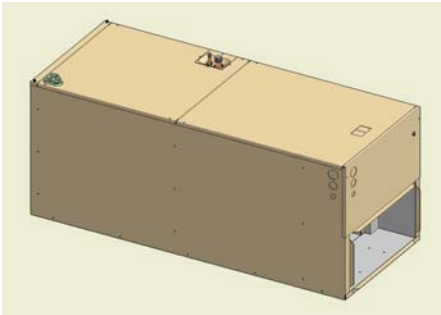

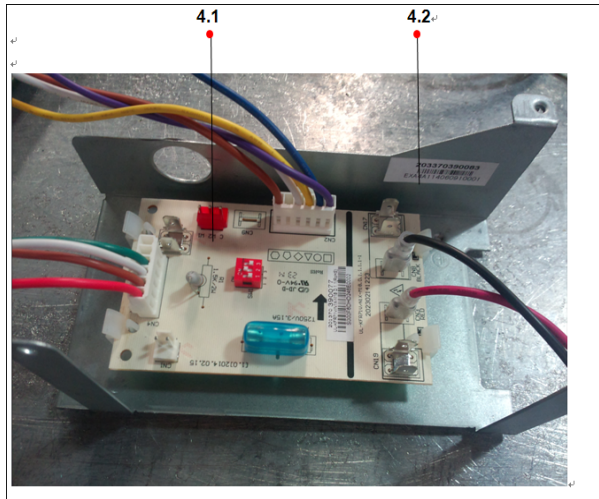

No.	Part Name	Quantity	BOM code	York Model	Remark
1	Side board ass'y	1	201M270890064	YMSJXC (H) 048BAAN--X	
2	Grounding terminal	1	202M301440007	YMSJXC (H) 048BAAN--X	
3	Air duct ass'y	1	201M270890101	YMSJXC (H) 048BAAN--X	
4	E-part box ass'y	1	203M370390083	YMSJXC (H) 048BAAN--X	
4.1	Main control board ass'y	1	201M370390077	YMSJXC (H) 048BAAN--X	recommended
4.2	Electric installation board	1	201M270590096	YMSJXC (H) 048BAAN--X	
5	Transformer	1	202M300930295	YMSJXC (H) 048BAAN--X	recommended
6	Base ass'y	1	201M270890076	YMSJXC (H) 048BAAN--X	
7	Water tray supporting welding pieces III	1	201M270890133	YMSJXC (H) 048BAAN--X	
8	Drainage pan supporter ass'y	1	201M270890135	YMSJXC (H) 048BAAN--X	
9	Supporter ass'y	1	201M270890107	YMSJXC (H) 048BAAN--X	
10	Drainage pan supporting board	1	201M270890066	YMSJXC (H) 048BAAN--X	
11	Drainage pan supporting board	1	201M270890067	YMSJXC (H) 048BAAN--X	
12	Supporting bar	1	201M270890069	YMSJXC (H) 048BAAN--X	
13	Cover board	1	201M270890065	YMSJXC (H) 048BAAN--X	
14	Evaporator ass'y	1	201M570790132	YMSJXC (H) 048BAAN--X	
14.1	Evaporator	1	201M570590122	YMSJXC (H) 048BAAN--X	
14.2	Evaporator	1	201M570590123	YMSJXC (H) 048BAAN--X	
14.3	Evaporator output pipe ass'y	1	201M670790308	YMSJXC (H) 048BAAN--X	
14.4	Evaporator input pipe ass'y	1	201M670790310	YMSJXC (H) 048BAAN--X	
14.4.1	Distributor	1	201M600500118	YMSJXC (H) 048BAAN--X	
14.4.2	Expansion valve	1	201M601300508	YMSJXC (H) 048BAAN--X	
15	Drainage pan	1	201M270890068	YMSJXC (H) 048BAAN--X	
16	Drain pan ass'y	1	201M170890005	YMSJXC (H) 048BAAN--X	
17	Drainage pan clap	1	201M270390194	YMSJXC (H) 048BAAN--X	
18	2 water tray brace	2	201M270390363	YMSJXC (H) 048BAAN--X	
19	Underside board ass'y	1	201M270890074	YMSJXC (H) 048BAAN--X	
20	Cover plate ass'y	1	201M270390192	YMSJXC (H) 048BAAN--X	
21	Upside board ass'y	1	201M270890075	YMSJXC (H) 048BAAN--X	
22	Motor bracket II	1	201M270390273	YMSJXC (H) 048BAAN--X	
23	Motor bracket I	3	201M270390288	YMSJXC (H) 048BAAN--X	
24	Centrifugal fan	1	201M200300894	YMSJXC (H) 048BAAN--X	recommended
25	Motor	1	202M400300560	YMSJXC (H) 048BAAN--X	recommended

# Exploded view and spare part list

Model: YMSJXC(H) 060BAAN--X

Voltage: 208/230-60-1

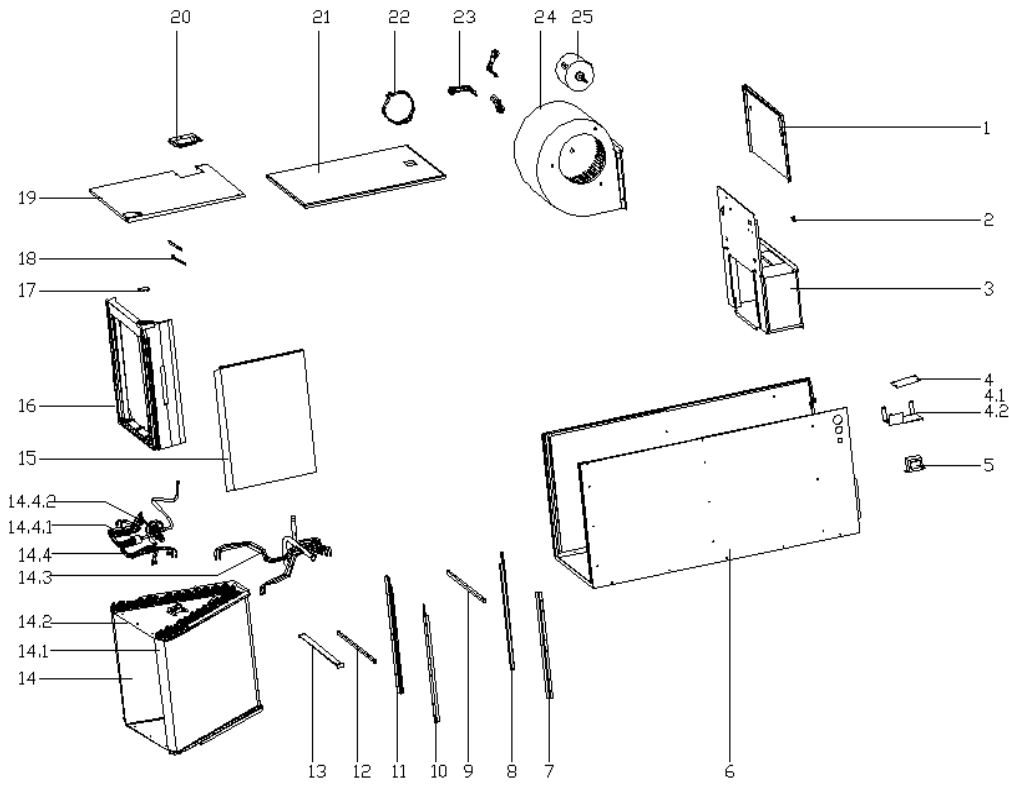
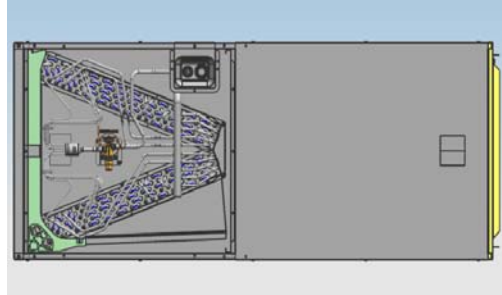
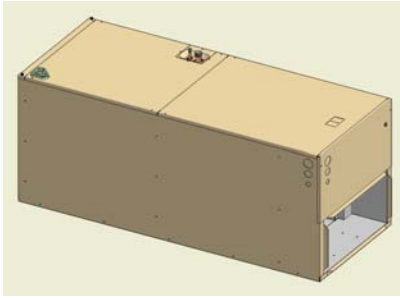

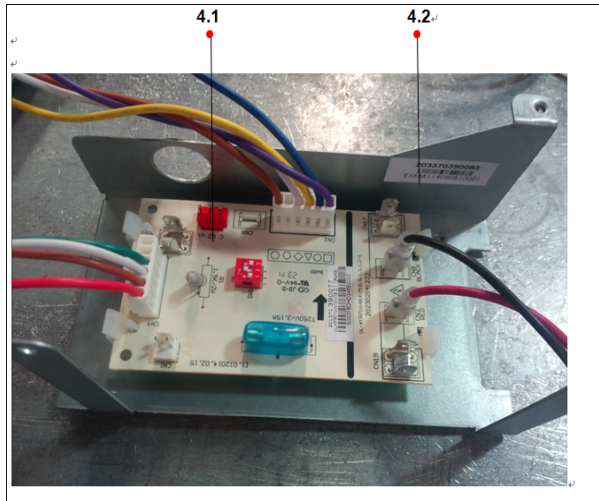

No.	Part Name	Quantity	BOM code	York Model	Remark
1	Side board ass'y	1	201M270890064	YMSJXC (H) 060BAAN--X	
2	Grounding terminal	1	202M301440007	YMSJXC (H) 060BAAN--X	
3	Air duct ass'y	1	201M270890101	YMSJXC (H) 060BAAN--X	
4	E-part box ass'y	1	203M370390083	YMSJXC (H) 060BAAN--X	
4.1	Main control board ass'y	1	201M370390077	YMSJXC (H) 060BAAN--X	recommended
4.2	Electric installation board	1	201M270590096	YMSJXC (H) 060BAAN--X	
5	Transformer	1	202M300930295	YMSJXC (H) 060BAAN--X	recommended
6	Base ass'y	1	201M270890076	YMSJXC (H) 060BAAN--X	
7	Water tray supporting welding pieces III	1	201M270890133	YMSJXC (H) 060BAAN--X	
8	Drainage pan supporter ass'y	1	201M270890135	YMSJXC (H) 060BAAN--X	
9	Supporter ass'y	1	201M270890107	YMSJXC (H) 060BAAN--X	
10	Drainage pan supporting board	1	201M270890067	YMSJXC (H) 060BAAN--X	
11	Drainage pan supporting board	1	201M270890066	YMSJXC (H) 060BAAN--X	
12	Supporting bar	1	201M270890069	YMSJXC (H) 060BAAN--X	
13	Cover board	1	201M270890065	YMSJXC (H) 060BAAN--X	
14	Evaporator ass'y	1	201M570890133	YMSJXC (H) 060BAAN--X	
14.1	Evaporator	1	201M570890106	YMSJXC (H) 060BAAN--X	
14.2	Evaporator	1	201M570890105	YMSJXC (H) 060BAAN--X	
14.3	Evaporator output pipe ass'y	1	201M670890350	YMSJXC (H) 060BAAN--X	
14.4	Evaporator input pipe ass'y	1	201M670890357	YMSJXC (H) 060BAAN--X	
14.4.1	Distributor	1	201M600500118	YMSJXC (H) 060BAAN--X	
14.4.2	Thermostatic expansion valve	1	201M601300513	YMSJXC (H) 060BAAN--X	
15	Drainage pan	1	201M270890068	YMSJXC (H) 060BAAN--X	
16	Drain pan ass'y	1	201M170890005	YMSJXC (H) 060BAAN--X	
17	Drainage pan clap	1	201M270390194	YMSJXC (H) 060BAAN--X	
18	2 water tray brace	2	201M270390363	YMSJXC (H) 060BAAN--X	
19	Underside board ass'y	1	201M270890074	YMSJXC (H) 060BAAN--X	
20	Cover plate ass'y	1	201M270390192	YMSJXC (H) 060BAAN--X	
21	Upside board ass'y	1	201M270890075	YMSJXC (H) 060BAAN--X	
22	Motor bracket II	1	201M270390273	YMSJXC (H) 060BAAN--X	
23	Motor bracket I	3	201M270390288	YMSJXC (H) 060BAAN--X	
24	Centrifugal fan	1	201M200300894	YMSJXC (H) 060BAAN--X	recommended
25	Motor	1	202M400300560	YMSJXC (H) 060BAAN--X	recommended